



**RESERVOIR EQUIPE
ASSEMBLED AIR RECEIVER
TYPE GVS1RV1000**

1000l 30bar vertical

1000l 435psi vertical

REF.0358190.130A

Pour tout renseignement complémentaire ne figurant pas dans ce document s'adresser à :
For any further information which does not appear on this document, please enquire to:

GALI FRANCE S.A.

1, rue Barthélémy Thimonnier

Z.I. 66200 ELNE (FRANCE)

Tél. 33(0)4 68 22 20 05 - Fax. 33(0)4 68 22 47 44

e.mail : comfr@gali-france.fr / comexp@gali-francefr

RESERVOIR EQUIPE ASSEMBLED AIR RECEIVER

1RV1000

CARACTERISTIQUES TECHNIQUES TECHNICAL DATA		
Pression de service maximum <i>Maximum working pressure</i>	bar psi	32 464
Volume <i>Capacity</i>	l l	1x1000 1x1000
Pression d'utilisation <i>Using pressure</i>	bar psi	30 435
Pression d'épreuve <i>Test pressure</i>	bar psi	49,5 718
Température ambiante <i>Ambiant temperature</i>	°C °F	-10° +50° ⁽¹⁾ 14° +122° ⁽¹⁾
Code de construction <i>Construction code</i>	-	AD.2000 ⁽²⁾ AD.2000 ⁽²⁾
Raccordement de remplissage (raccordement femelle gaz Rp) <i>Filling connection (gaz female connection :Rp)</i>	-	1/2" ⁽³⁾ 1/2" ⁽³⁾
Raccordement de sortie (raccordement femelle gaz Rp) <i>Outlet connection (gaz female connection :Rp)</i>	-	1" ⁽³⁾ 1" ⁽³⁾
Alarme pression basse <i>Low pressure alarm</i>	-	Option Optional
Soupape de sûreté <i>Safety valve</i>	-	32 bar laiton CE 464 psi brass CE
Manomètre (marquage à 30 bar) <i>Pressure gauge (30 bar marking)</i>	-	Ø63 cl.1,6 0-60bar Ø63 cl.1,6 0-60bar
Vannes <i>Manual valves</i>	-	Inox. 316L cadennassable ss 316L lockable
Peinture extérieure ⁽⁴⁾ (couleur) <i>Painting external⁽⁴⁾ (color)</i>	-	RAL5005 ⁽⁵⁾ RAL5005 ⁽⁵⁾

(1) Autre température sur demande.

(1) Other temperature on request.

(4) Peinture intérieure sur demande.

(4) Inside painting on request.

(2) Autre construction ou réception sur demande.

(2) Other build or reception on request.

(7) Autre couleur ou peinture suivant spécification sur demande.

(7) Other color or painting according to specification on request.

(3) Autre raccordement sur demande.

(3) Other connection on request.

Conforme à la directive européenne : 97/23/CE.
According to the european directive : 97/23/CE.

SCHEMA DE PRINCIPE PRINCIPLE DIAGRAM

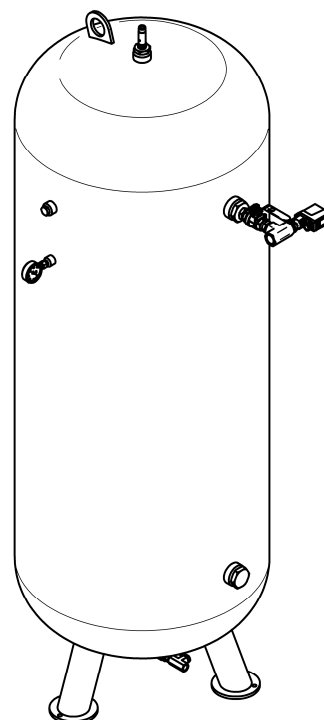
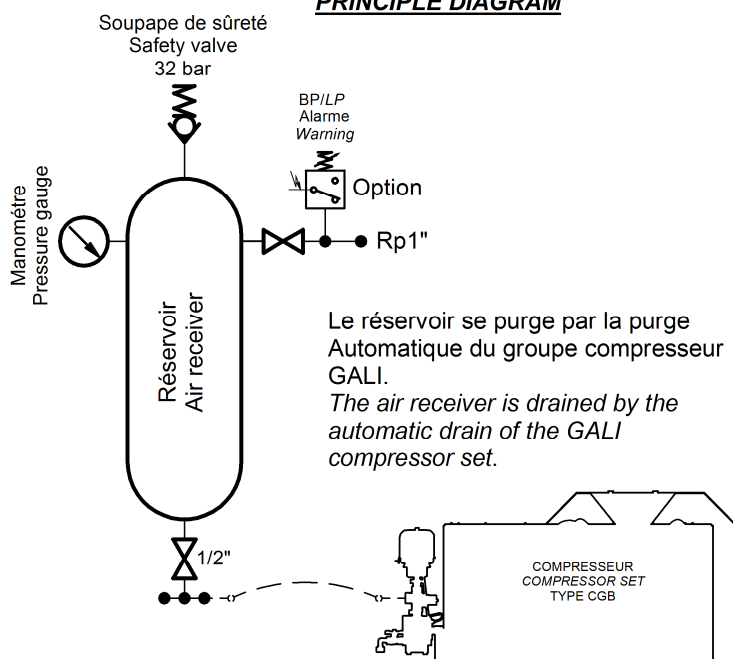

Données techniques sans engagement.
Technical data not binding.

gali FRANCE, S.A.

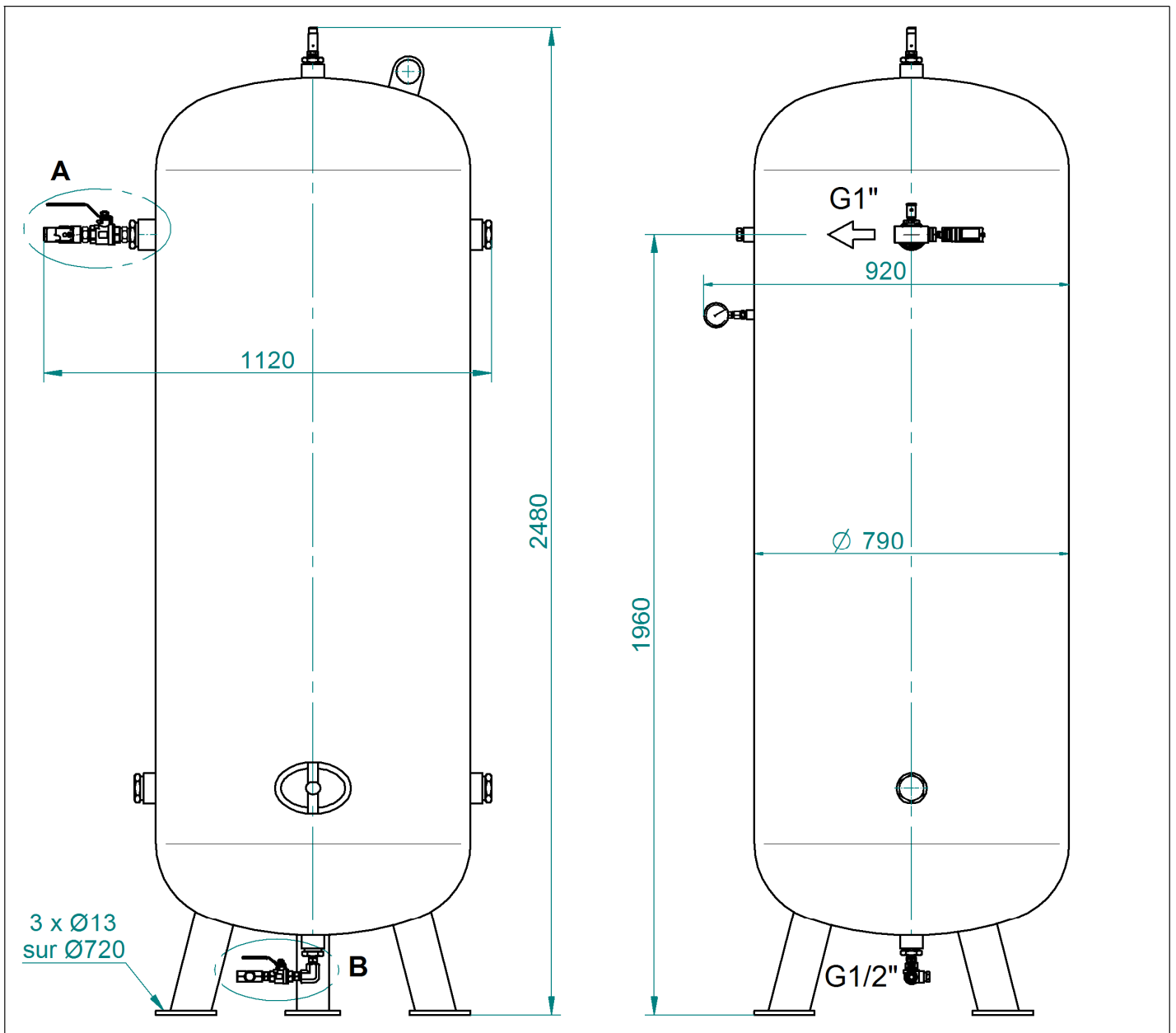

DETAIL A

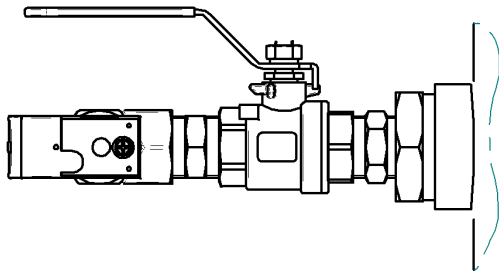

DETAIL B

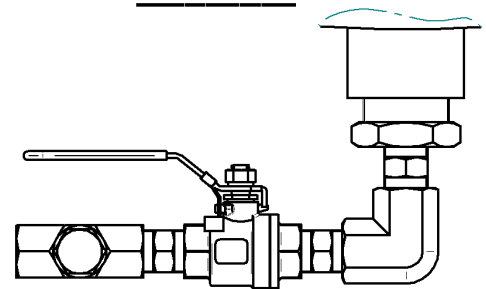

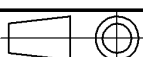
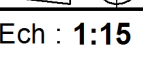
IND.	DATE	DETAIL DES MODIFICATIONS	
CE PLAN EST NOTRE PROPRIÉTÉ ET NE PEUT ÊTRE COMMUNIQUÉ OU REPRODUIT SANS NOTRE AUTORISATION			
SIEGE & DIRECTION ZI. 66200 ELNE TEL: +33 (0)4 68 22 20 05 FAX: 33 (0)4 68 22 47 44		 RESERVOIR EQUIPE ASSEMBLY AIR RECEIVER TYPE GVS1RV1000 30 bar	
DES. PUIGNAN.V 			
VER. T.Barcelo  Ech : 1:15		DATE : 07/10/05 PLAN N° 6565	A4 PAGE : 1/2 IND. a